

RoHS  
Compliant

Ordering information:  
TJ 13 16 LS P 10 0720 B 6  
(1) (2) (3) (4) (5) (6) (7) (8) (9)

**SPECIFICATION:**

- CURRENT RATING: 5.0 A
- VOLTAGE RATING: 5.0 V
- VBUS & GND PINS AND OTHER PINS: 40mΩ/PIN MAX  
SHIELD: 50mΩ/MAX  
LLCR MAX. CHANGE OF ALL PINS: 10mΩ
- INSULATION RESISTANCE: 100MΩ MIN
- DIELECTRIC WITHSTAND VOLTAGE, AC 100V FOR 1MINUTE
- INSERTION FORCE: 0.5~2.0kgf
- UNMATING FORCE: 0.8~2.0kgf
- DURABILITY: 10000 CYCLES
- OPERATING TEMPERATURE: -25°C~+85°C
- THE PEAK TEMPERATURE ON THE BOARD SHALL BE MAINTAINED FOR 10 SECONDS AT 260°C
- WATERPROOF: IPX6

- (1): Manufacture ref TJ= TENGJUN  
(2): line number  
(3): Pin Number  
(4): H= 立式 L= 卧式 F= 沉板 C= 侧式  
D= 插件 S= 贴板 W= 焊线  
(5) shape: P= 平口, W= 舌片外露  
(6) 定位柱: 1= 带柱, 0= 无柱  
1= 带弹, 0= 无弹  
(7) 0720= 7.2mm (L/H)  
(8) 胶芯颜色: 黑=B, 红=R, 绿=G, 蓝=L, 黄=Y, 橙=O, 粉=P  
(9) Waterproof: 7= IPX7, 8= IPX8, 0= not waterproof  
(10) 板上中心高度 CH= 1.68

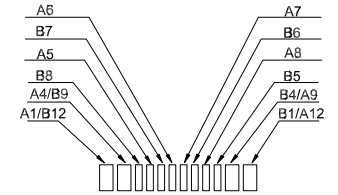
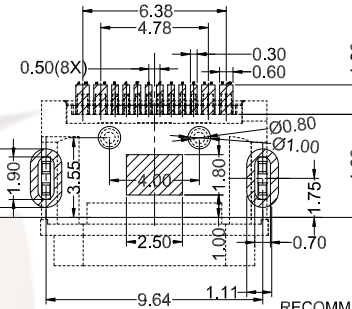
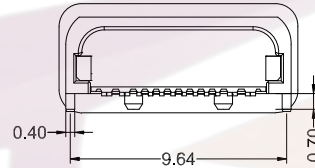
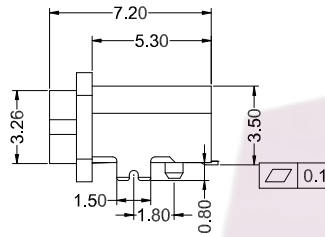
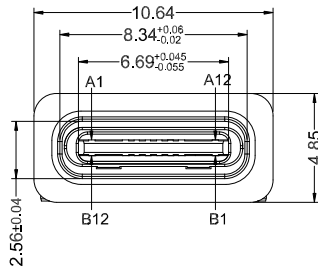
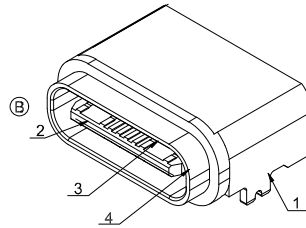
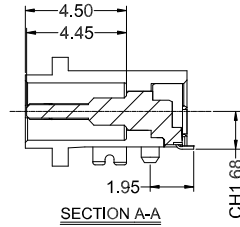
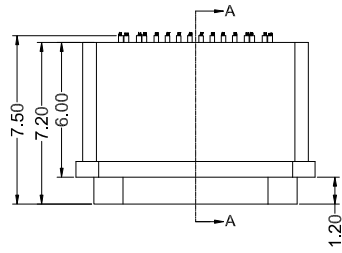

RECOMMENDED PCB LAYOUT  
TOLERANCE: ±0.05

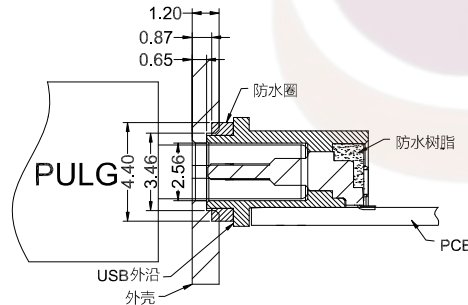
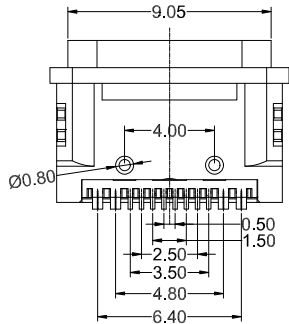

RECOMMENDED ASSEMBLY DRAWING

A1	A2	A3	A4	A5	A6	A7	A8	A9	A10	A11	A12
GND			VBUS	CC1	D+	D-	SBU1	VBUS			GND
B12	B11	B10	B9	B8	B7	B6	B5	B4	B3	B2	B1
GND			VBUS	SBU2	D-	D+	CC2	VBUS			GND

1	SHELL	ZINC ALLOY	ZINC ALLOY Ni PLATED
2	MID PLATE	STAINLESS STEEL	SUS304 NO PLATED
3	HOUSING	HIGH TEMPERATURE PLASTIC	PA9T BLACK UL 94 V-0
4	CONTACT	COPPER ALLOY(C7025)	Au PLATING ON CONTACT AREA
5	WATERPROOF RING	SILICA GEL	/
NO.	PARTS	MATERIAL	REMARKS

Guangdong Tengjun Electronic Technology Co., Ltd

Website:

<https://www.tengjunconn.com>

TEL:

0769-23323869



PART NAME	防水TYPE-C 16PIN SMT 两脚插板
PART NO.	TJ1316LSP100720B6

TOLERANCE UNLESS OTHERWISE SPECIFIED:	
X	±0.2
X.X	±0.15
X.XX	±0.10
X.XXX	±0.050

DRAWING:	Li	DATE:	2022.09.18	SCALE	SHEET	REV:A0
CHECK:	Chen	DATE:	2022.09.18	1:1	1/2	SIZE:A4
APPROVAL:	Yuan	DATE:	2022.09.18			

RoHS  
Compliant

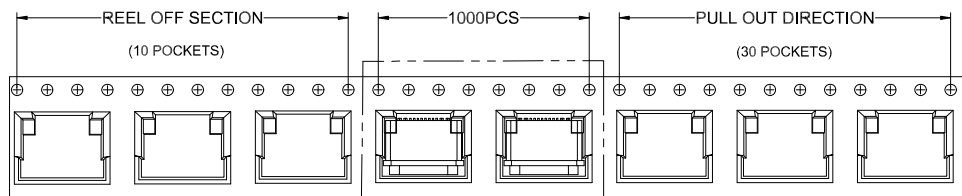

SEE DETAIL X

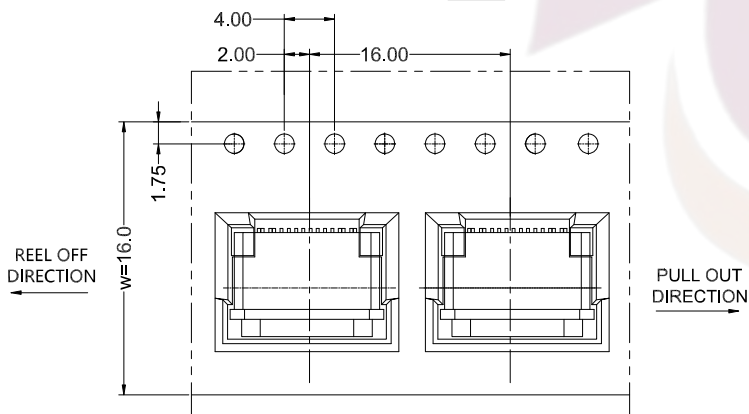
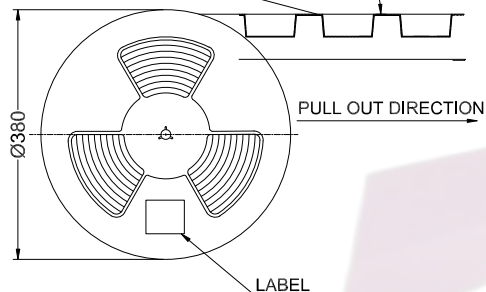
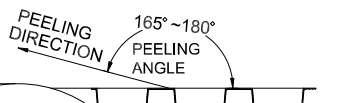

PAPER BOARD

REEL AND TAPE

REEL AND TAPE

PAPER BOARD

FOLDER  
PAPER BOARD

CARTON

	REEL	CARTON
CONNECTOR (PCS)	1000	10000

Guangdong Tengjun Electronic Technology Co., Ltd

Website:

<https://www.tengjunconn.com>

TEL:

0769-23323869



PART NAME

防水TYPE-C 16PIN SMT  
两脚插板-包装图

PART NO.

TJ1316LSP100720B6

TOLERANCE UNLESS OTHERWISE SPECIFIED:  
X ±0.2  
X.X ±0.15  
X.XX ±0.10  
X.XXX ±0.050

DRAWING:

Li

DATE:

2022.09.18

SCALE

SHEET

REV:A0

CHECK:

Chen

DATE:

2022.09.18

1:1

2/2

SIZE: A4

APPROVAL:

Yuan

DATE:

2022.09.18

